



19th Asian Games
Hangzhou 2022



吉利汽车
GEELY AUTO

GEELY

杭州2022年亚运会官方合作伙伴
Official Prestige Partner of the 19th Asian Games Hangzhou 2022

吉利汽車控股有限公司

GEELY AUTOMOBILE HOLDINGS LIMITED

公司介紹演示 Corporate Presentation

2022年5月 May 2022



於開曼群島註冊成立的有限公司 (香港股票號碼: 00175)

A company incorporated in Cayman Islands with limited liability (HK Stock Code: 00175)

www.geelyauto.com.hk

銷量縱覽

Sales Volume Overview

單位: 千部
unit: K

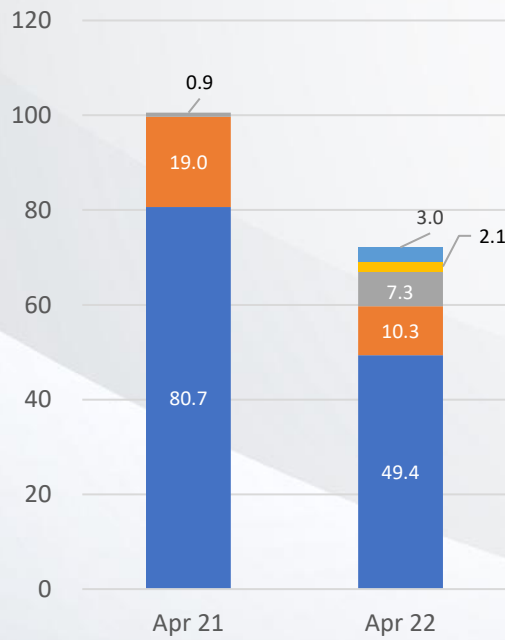

■ 吉利 Geely ■ 領克 Lynk&Co ■ 幾何 Geometry ■ 極氪 Zeekr ■ 睿藍 Livan

按年 YoY: 1%

新能源汽車銷量縱覽

NEV Sales Volume Overview

單位: 千部
unit: K

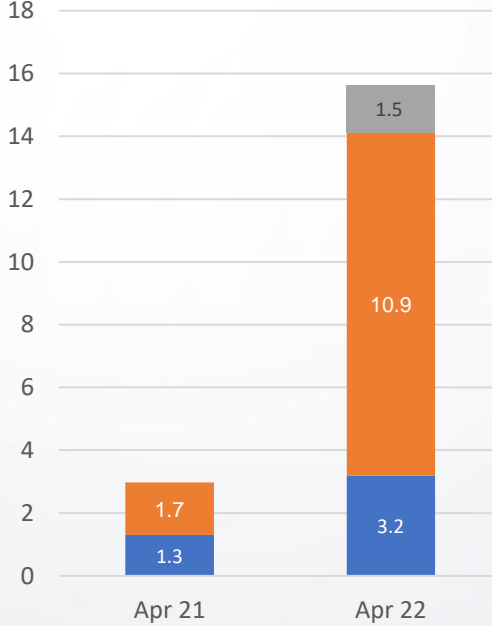

■ 插電混動 PHEV ■ 純電動 BEV ■ 混動 HEV

按年 YoY: +305%

出口銷量縱覽

Export Sales Volume Overview

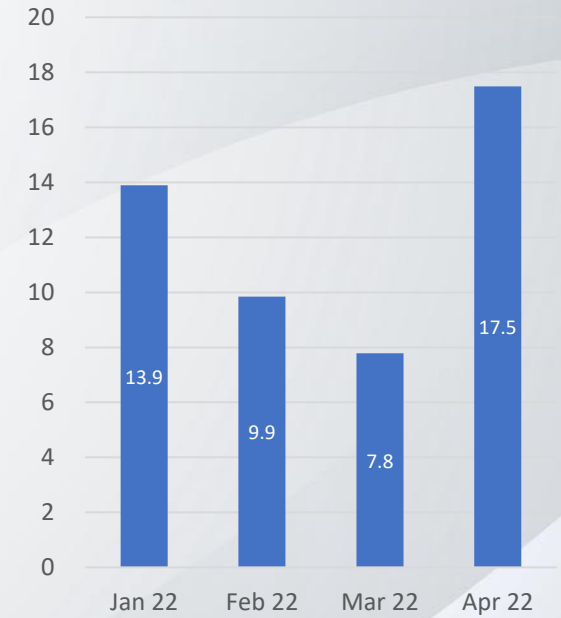

■ 出口 Export

按月: MoM: -18.9%

按年: YoY: +38.5%

連續4年為中國汽車自主品牌銷量排名第一

Ranked No.1 in terms of sales volume among all the local brands for consecutive 4 years.

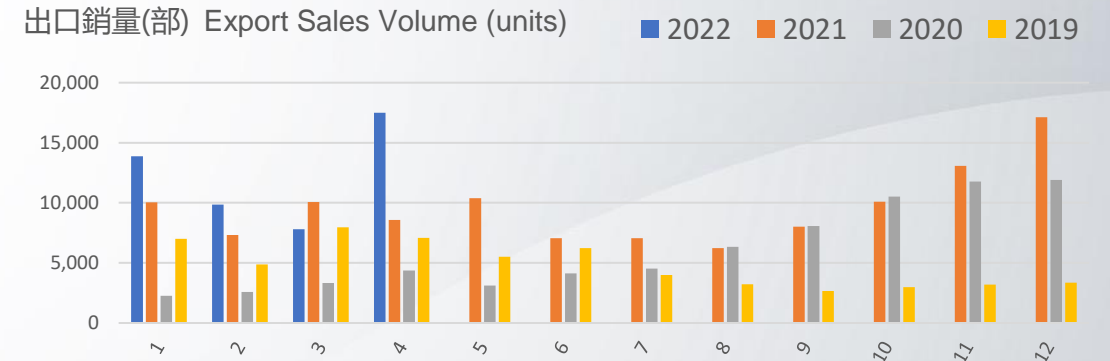
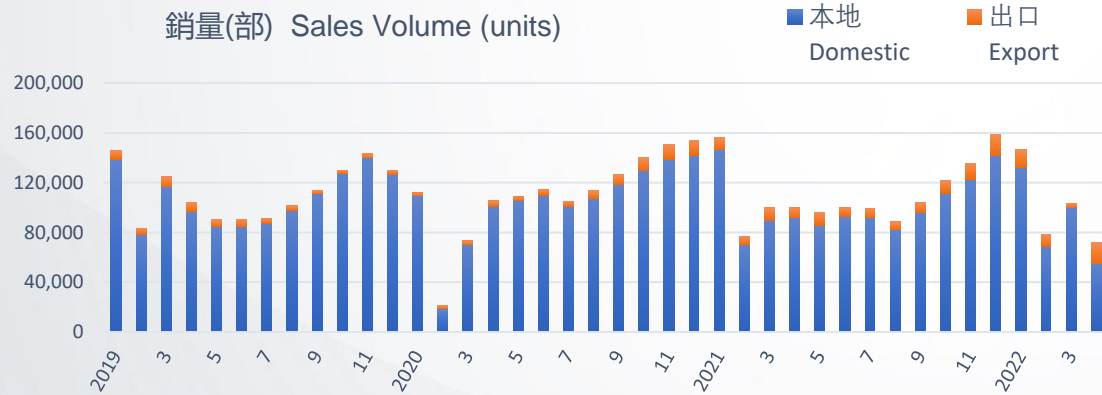

國內市佔率 Market Share in China*

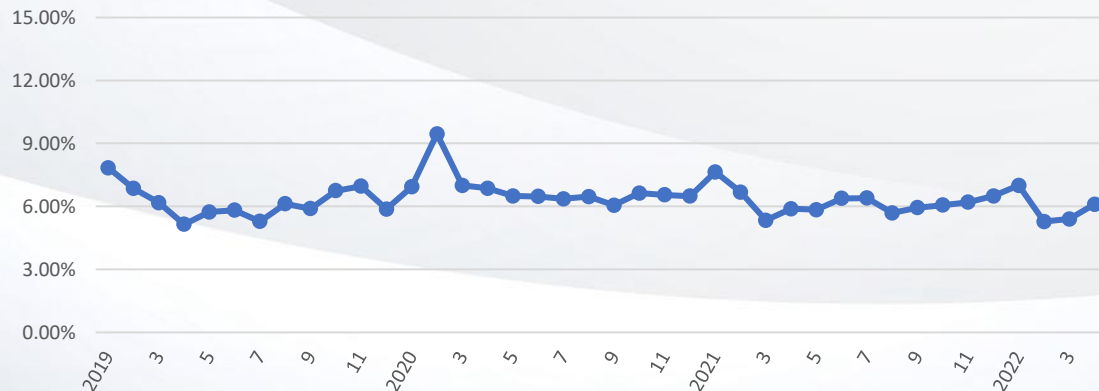

新能源汽車銷量(部) NEV Sales Volume (units)

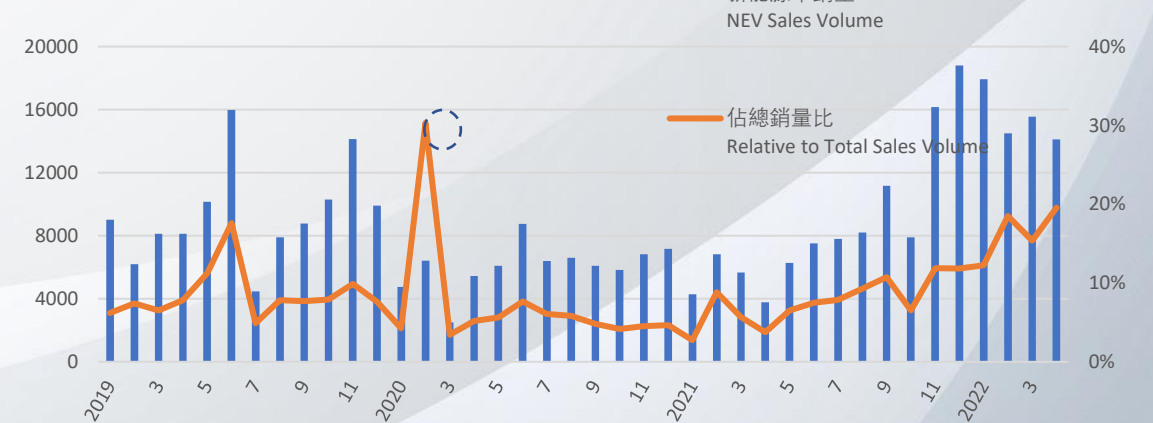

*數據來自中國汽車工業協會

*Data from China Association of Automobile Manufacturers (CAAM)

因該月新冠疫情在中國大陸爆發，整體交付大幅下滑，引致新能源汽车銷量佔比陡增。

Due to the Covid-19 outbreak in mainland China, overall deliveries fell significantly in Feb 2020, resulting in a sharp increase of NEV sales percentage.

實施多品牌戰略，覆蓋絕大部分汽車消費市場。

Implement multi-brands strategy to cover most of the automobile market.

利用公司動力總成能力提供多元化產品以滿足客戶需求。

Leverage on the company's powertrain capabilities by offering different products to fulfill the customer demands.



2021年產品動力總成組合
Product Powertrain Portfolio in 2021

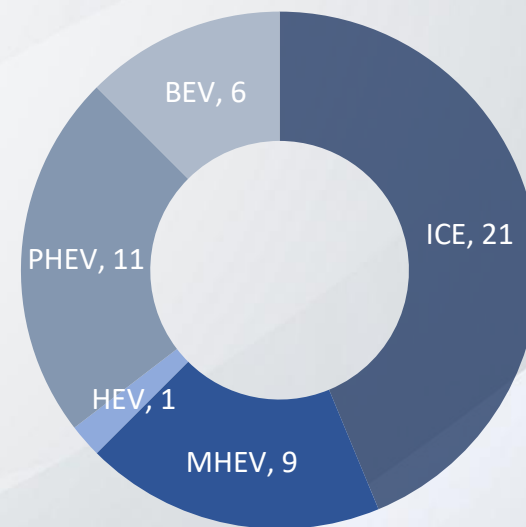

單位：款 unit: version

■ ICE ■ MHEV ■ HEV ■ PHEV ■ BEV



- 針對大眾乘用車市場，以“造每個人的精品車”為品牌願景。推出轎車，SUV，MPV等17款主要車型。
- 帝豪轎車系列常年為中國最暢銷自主品牌轎車；SUV銷量為中國自主前三。
- 吉利品牌2021年H1平均指導價人民幣7.5萬元。
- 2022年3月開始全面升級動力總成，搭載1.5T四缸發動機。
- 出口東南亞，東歐，中東等多國市場。
- Targeting the mass market. Brand vision: “Making Refined Cars for Everyone”. Provide 17 major models covering sedan, SUV and MPV.
- The Emgrand sedan is the most popular sedan model among all the domestic brands in China. SUV sales ranked top 3 in the Chinese market.
- Geely brand 2021 H1 Average Selling Price of RMB 75K.
- New powertrain upgrade starts in March 2022 with a newly designed 4 cylinder 1.5T engine.
- Export to Southeast Asia, Eastern Europe and Middle East countries.

除中國星系列外主要車型月度銷量(部)
Monthly Sales Volume of Major Models excl. China Star Series (units)

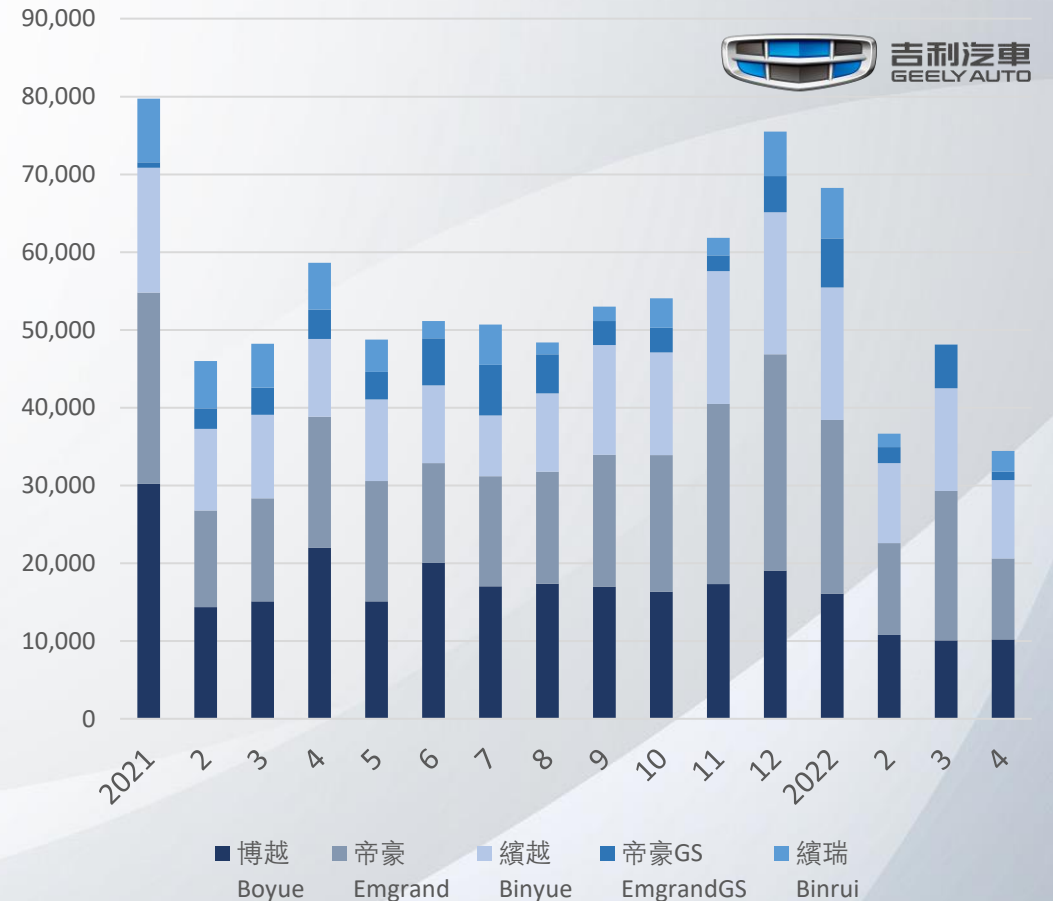

中國星系列 China Star Series



- 吉利品牌旗下高端系列，滿足用戶消費升級需求。
- 3款車型基于CMA模塊化架構平臺:星越L、星越S、星瑞。
- 平均指導價為人民幣15萬元以上。
- 星越L混動車型已于2022年3月開始交付。
- High-end series under Geely brand, to fulfill consumption upgrade demand.
- 3 models based on CMA platform: Xingyue L, Xingyue S, Preface.
- Average Selling Price of RMB150K+.
- Delivery of Xingyue L HEV since March 2022.

月度銷量(部) Monthly Sales Volume (units) ■ 星越S Xingyue S ■ 星越L Xingyue L ■ 星瑞 Preface

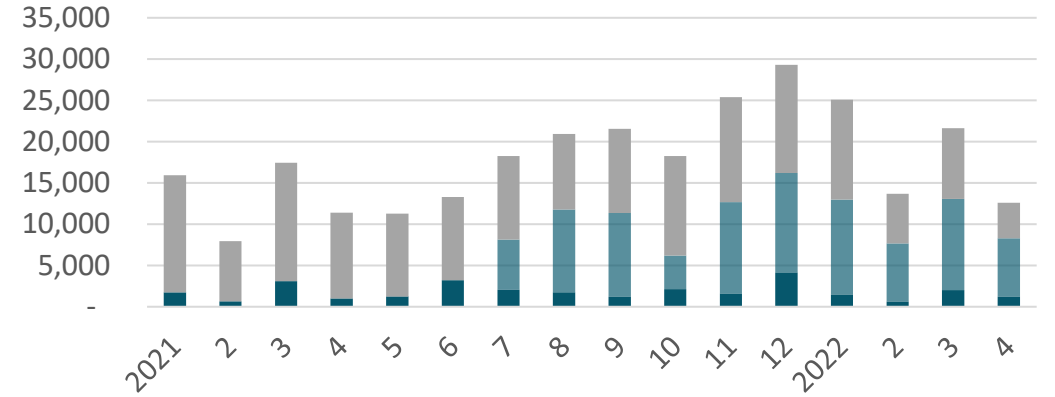

吉利星越L



尺寸Size:

- 4770*1895*1689 cm
- 軸距 wheelbase: 2845 cm

發動機選擇Powertrain choices:

- 燃油ICE: 2.0TD+7DCT/8AT, max 175Kw, max 350 Nm
- 混動HEV: 3 speed DHT, 4.3L/100Km

智能配置Smart features:

- 5 domain E/E structure
- 3X12.3 inch screens, Qualcomm 8155
- APA/LCC/AEB/LDW/LCA/HUD

几何汽车 GEOMETRY



月度銷量(部) Monthly Sales Volume (units)

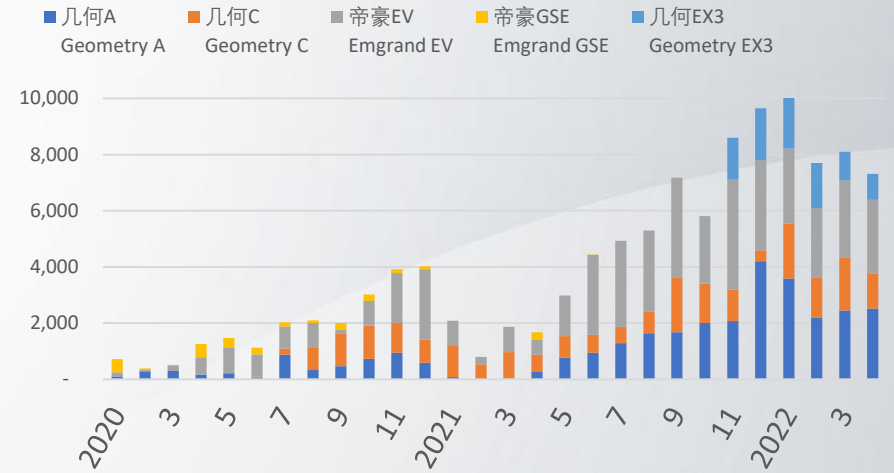

- 以全球大眾純電車市場為目標之子品牌。
 - 在售主力車型之平均指導價格為人民幣13萬元。
 - A00級SUV新產品將於2022年推出。
- A pure electric sub-brand targeting the global mass BEV market.
 - Currently major models are launched with Average Selling Price of RMB130K.
 - New product A00 SUV will be launched in 2022.

LYNK & CO

- 進入高端市場最成功的自主品牌之一，自2017年12月發運66萬部以上。
 - 以開放，互聯為品牌精神，平均指導價至人民幣13萬元以上。
 - 基於CMA/SPA/BMA 模塊化架構平臺推出7款車型覆蓋轎車及SUV。
 - 自2021年開始透過訂閱或直銷進入西歐及中東發達國家市場。
- One of the most successful local brands entered the premium market with 660K+ units delivery since Dec 2017.
 - Bold image targeting premium market customers for openness and connectivity to the world as brand spirit, with Average Selling Price of RMB130K+.
 - Launched 7 models based on CMA/SPA/BMA platforms cover sedan and SUV.
 - Entered developed markets in Western Europe and Middle East countries through reservations or direct sales since 2021.



月度銷量(部) Monthly Sales Volume (units) ■ 01 ■ 02 ■ 03 ■ 05 ■ 06 ■ 09

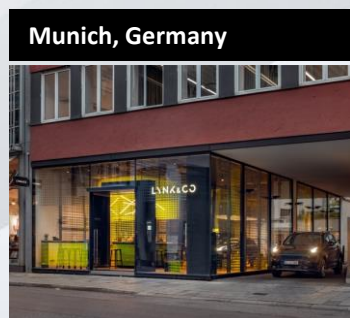
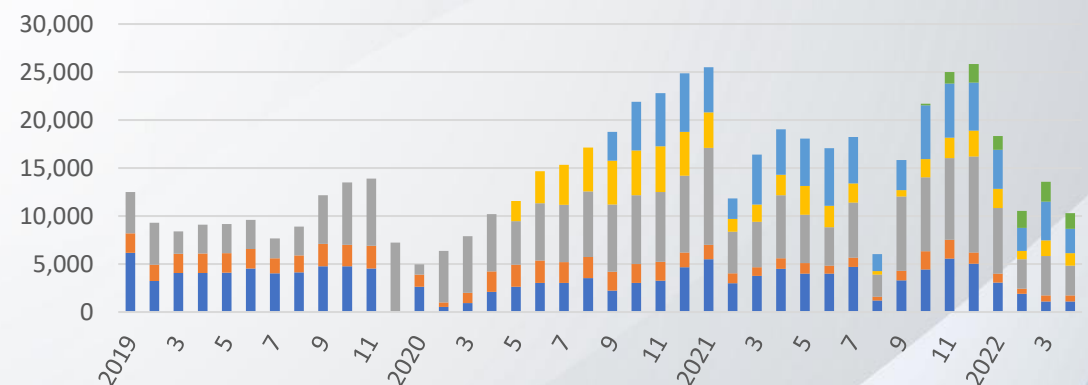



ZEEKR



- 與吉利控股成立之合營公司，占比58%。
 - 於2021年成立之高端智能電動車品牌，自2021年10月始交付。
 - 基於SEA模塊化架構平臺的極氪001車型，平均指導價人民幣33.5萬元。
 - 采用直營銷售方式，2022年底直銷實體（包括極氪中心及極氪空間）店超過300家。
- A joint venture with Geely Holding at 58% shareholding.
 - High-end intelligent EV brand established in 2021, delivery since Oct 21.
 - Zeekr 001 the first model based on SEA platform started delivery in 2021 with Average Selling Price of RMB335K.
 - Direct selling business model with over 300+ direct sales stores (incl. Zeekr Centre and Zeekr Space) by end of 2022.

月度交付量(部) Monthly Delivery (units)

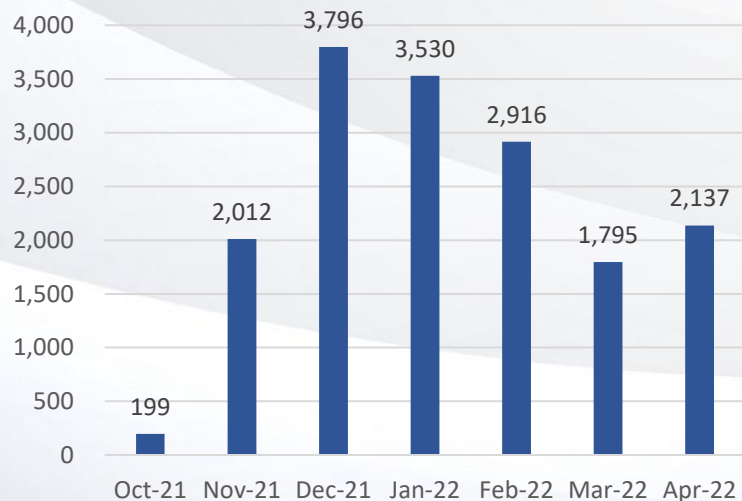

1月，極氪線下門店新增8家，其中包括4家空間店及4家快閃店

In Jan, newly opened 8 off-line stores, among which 4 were Zeekr Space and 4 were Pop-up stores.

註：線下直銷實體包括極氪中心、極氪空間及快閃店

Note: Off-line direct sales stores include Zeekr Centre, Zeekr Space and Pop-up store.

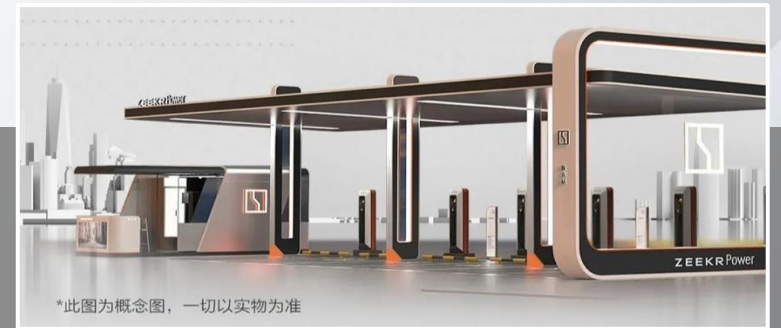

自建充電站已在全國19座城市上線。第三方充電網絡已覆蓋全國331座城市中的近31萬個充電終端

Self-built battery charging stations are in operation in 19 cities nationwide. Nearly 310K third party charging terminals in 331 cities.



- 與力帆科技 (上海交易所:601777) 於2022年以50%/50%比例成立之合營公司
- 以打造具有競爭力的智能換電產品和服務為目標
- 由2021年公佈之智能吉利2025戰略導向
吉利將於2025年前推出5款智能換電車型目標銷量達20萬部
吉利將於2025年前在中國設置5,000個換電充電站
- 除換電充電服務及產品外，睿藍亦會在發展初期提供低端內燃機汽車

- A joint venture with Lifan (Shanghai stock exchange stock code: 601777) on a 50%/50% scale was established in 2022
- Targeting to create competitive intelligent battery swapping products and services
- Following Smart Geely 2025 initiative announced in 2021
Geely will launch 5 intelligent BEV models with target sales of 200K units by 2025
Geely will set up 5K battery swapping stations in China by 2025
- Besides battery swapping services and products, Livan will also provide low end ICE cars at the early stage of its development



- 與BNPP PFI以80%/20%規模成立的合資企業
- 為吉利品牌提供汽車融資服務：吉利汽車、領克、幾何、極氪和沃爾沃
- 零售不良貸款(60天以上)：2021年僅為0.19%
- J.D. Power 2021中國經銷商融資滿意度調查零售信貸板塊排名第二

- A joint venture with BNPP PF on a 80%/20% scale
- Provides auto financing services to Geely brands: Geely Auto, Lynk & Co, Geometry, Zeekr and Volvo
- Retail NPL (non-performing loan: 60+ days) at 0.19% in 2021
- Ranked No.2 in the retail credit segment of J.D. Power 2021 China Dealer Financing Satisfaction Study

CAGR: Compound Annual Growth Rate 年複合增長率

零售合約 (千部)
Retail Contracts (thousand unit)

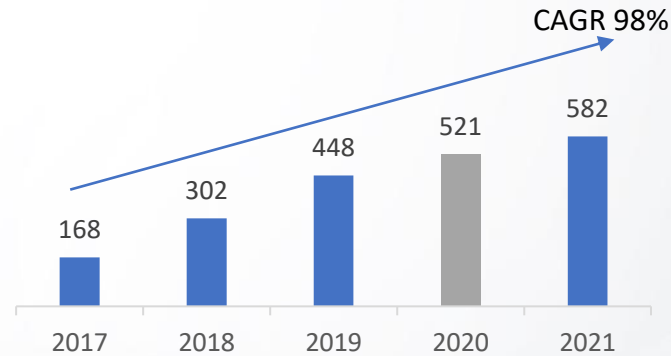

未償還總額(人民幣百萬元)
Total Outstanding Loan Assets (RMB Mn)

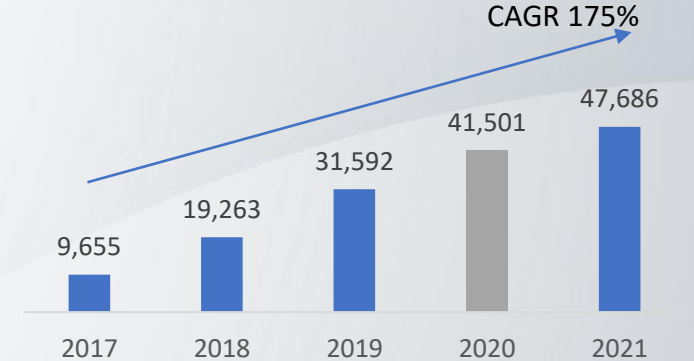

淨利 (人民幣百萬元)
Net Profit (RMB Mn)

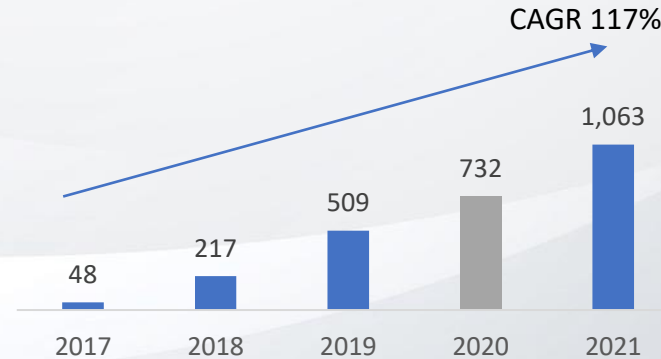

零售滲透率
Retail Penetration

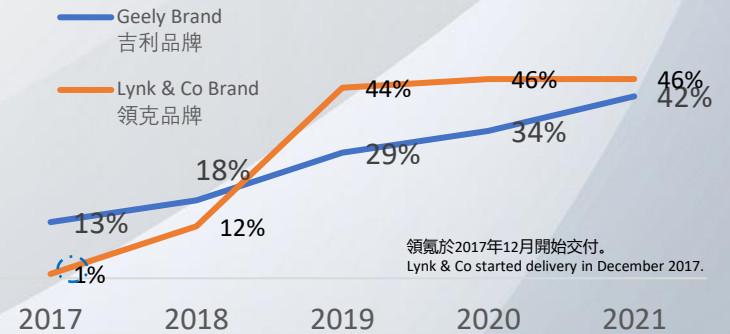

作為公司主要技術優勢之一，吉利的目標是逐步將大部分車型轉移到模塊化架構。2021年50%的銷售額來自模塊化架構，預計在2022年該佔比會進一步增加。模塊化架構由吉利控股集團授權，並與其他品牌共享，以達至規模經濟。

As one of the company's major technical edges, Geely is targeting to gradually transform most of the models to modular architectures. 50% of the sales were from these platforms in Year 21 and estimated that would be increased further in Year 22. The Modular Architectures are licensed from the parent company and shared between other brands for economies of scale.

更高共性率
 Higher Commonality Rate

更短開發週期
 Shorter Development Cycle

更低生產成本
 Lower Manufacturing Cost

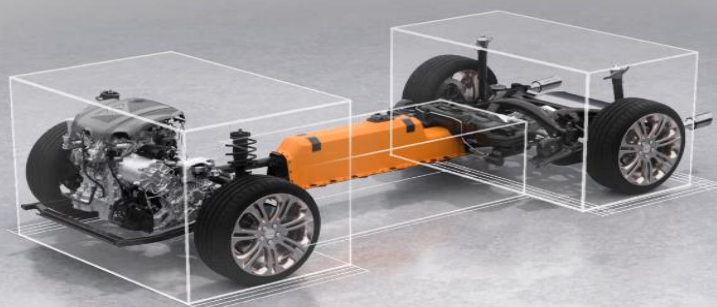

CMA



BMA

- 模塊化架構 (BMA、CMA、SPA、SEA) 覆蓋整個產品線
- A0/A/B/C/D/E 級車款均具有多種動力總成選項
- 先進具彈性的E/E架構

- Modular Architectures (BMA,CMA,SPA,SEA) to cover the entire product line
- A0/A/B/C/D/E segments with versatile powertrain options
- Advanced flexible E/E structure

純電模塊化架構旨在構建智能電動汽車生態

The Pure Electrical Modular Architecture is aiming to build up the Smart EV Ecosystem.

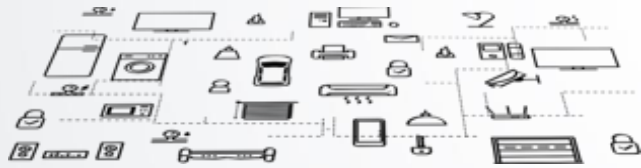

Ecosystem level

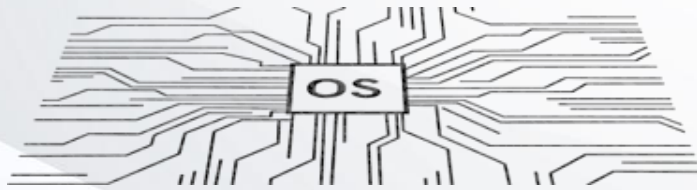

Software level

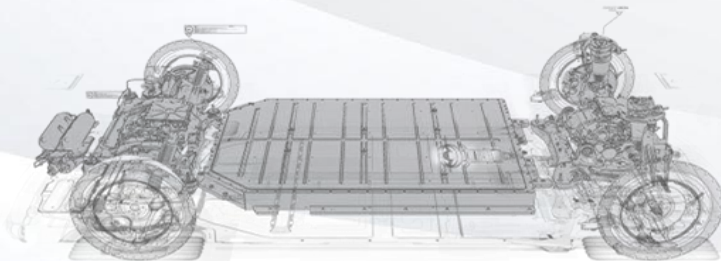

Hardware level

浩瀚 SEA

Sustainable | Experience | Architecture

- 至2021年止，7個品牌加入浩瀚生態：極氪、吉利、Smart、沃爾沃、極星、路特斯、集度
 - 覆蓋 A-E 級的寬帶寬度
 - 基于雲端的電鍍零件管理
 - 中央系統控制E/E結構
 - 2025年達到全自動駕駛
 - 浩瀚操作系統建構未來電動汽車生態系統
 - 開源電動汽車架構
-
- Seven brands joined SEA ecosystem by 2021 : Zeekr, Geely, Smart, Volvo, Polestar, Lotus, Jidu
 - Wide Band width covering A-E segment
 - Cloud based electric component management
 - Centralized domain control E/E structure
 - Fully Autonomous Driving from 2025
 - SEA OS to facilitate the future EV ecosystem
 - Open-Source Electric Vehicle Architecture

2022年計劃推出8款搭載雷神Hi-X混合動力車型

Targeted to launch 8 models equipped with Lei Shen Hi-X powertrains in Year 2022

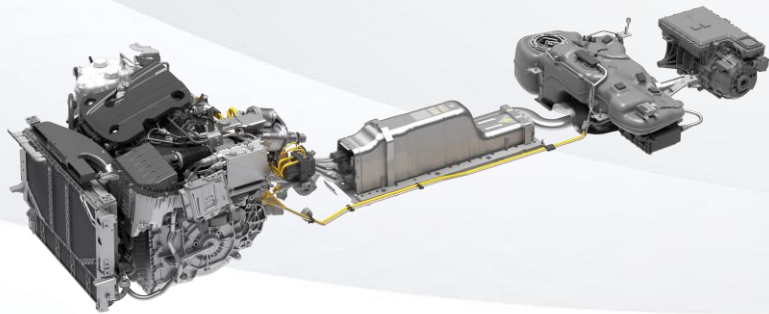
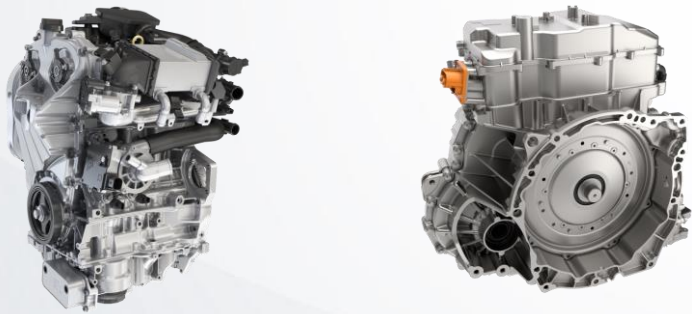

雷神智擎 Hi-X Lei Shen Hi-X

- 世界級模塊化智能混合動力平臺，涵蓋混動、插電混動、增程式
- 43.32%的世界級熱效率，節油率高達40%
- 首創三檔混動電驅，最大輸出扭矩4920N•m
- 支持固件遠程升級及20種智能駕駛模式

- World class modular intelligent hybrid platform covering HEV, PHEV, REEV
- World class thermal efficiency of 43.32%, Fuel savings up to 40%
- The first to launch 3-speed Dedicated Hybrid Transmission - DHT Pro, Max torque 4920N•m
- FOTA & 20 intelligent driving modes

從信息娛樂系統、數字座艙到中央計算的片上系統和操作系統能力

Equipped with SoC and operation system capabilities from infotainment, digital seat to central calculation



億咖通

ECARX

- 入股億咖通，加強智能化佈局
 - 於星越L、領克09等車型上成功搭載GEEA2.0架構，智能化體驗顯著提升
 - 億咖通旗下芯擎科技研發的中國第一顆7nm車規級SoC芯片流片成功
 - 銀河車機操作系統正式搭載在星越L上
 - 吉利汽車成為吉利控股集團智能生態一網三體系的重要參與者
-
- Being a shareholder of ECARX, strengthen intelligent layout
 - GEEA 2.0 architecture has been successfully installed on Xingyue L, Lynk 09 and other models, the intelligent experience has been significantly improved
 - China's first 7nm vehicle-grade SoC chip developed by The Core Engine Technology, a subsidiary of ECARX, was successfully taped out
 - Galaxy vehicle operating system is officially installed on Xingyue L
 - Geely Auto has become an important participant in Geely Holding Group's intelligent ecology, one network and three systems

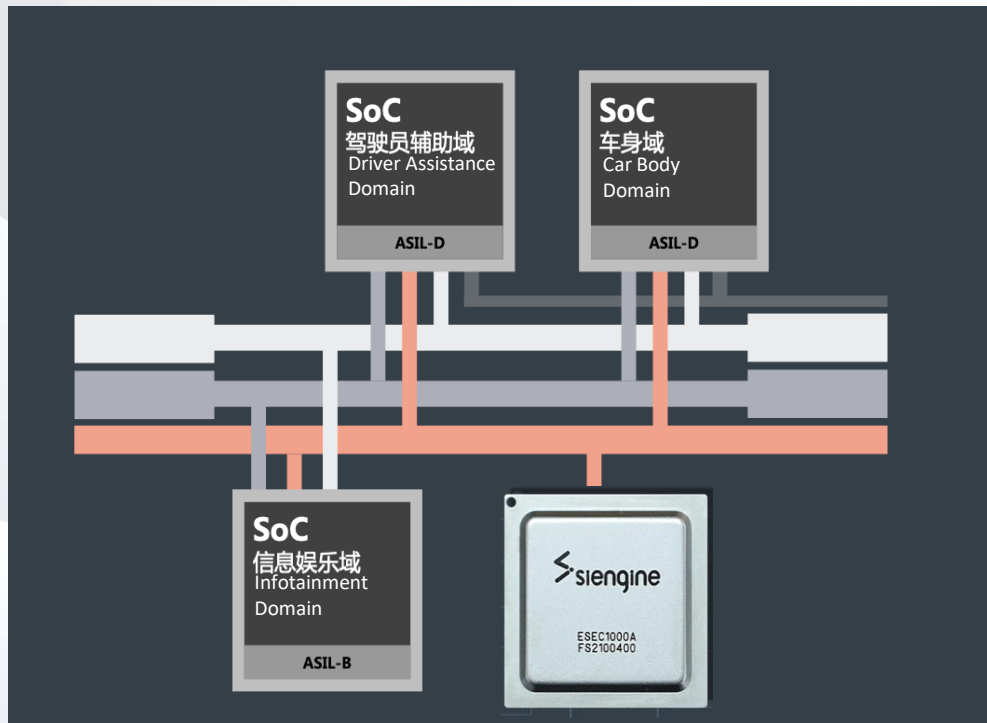

模塊化架構專為未來的全自動駕駛而設計。

The Modular Architectures are designed for Full Autonomous Driving in future.

2021**基本駕駛助理****Basic Driver Assistant**

- 大規模部署
- 作為數據收集的基礎
- 影子模式
- 支持OTA升級
- Mass deployment
- As basis of data collection
- Shadow Mode
- OTA Mode

2022**結構道路上的
進階自動駕駛****Advanced AD
On Structural Road**

- 強化連續自動駕駛能力
- 擴展使用場景：跨層泊車、隨機泊車、特定場景下實現L2/L3
- Maximize the duration of continuous auto pilot
- Rich Scenes; cross-layer parking, random parking, hands-off/eyes off in particular scene

2023**開放道路上的
進階自動駕駛****Advanced AD
On Open Road**

- 將L4應用于指定區域的停車場、高速公路、城市等場景
- Apply L4 (unsupervised) to the scenes like parking, highway, urban, etc. in specified regions

2025**全自動駕駛****Fully AD**

- 基於全棧SW、高清地圖、超腦等技術
- 實現全自動駕駛
- Based on technology as full stack SW, HD maps, super brain, etc.
- Achieve fully auto pilot



基于藍色吉利行動計劃，進一步提出碳排放目標設定：

Based on the Blue Geely Action Plan, further proposed carbon emission targets:

- 短期目標：以2020年為基準年，2025年單車全生命週期碳排放減少25%以上。
Short-term target: With 2020 as baseline, life cycle carbon emission per car reduced by more than 25% in 2025.
- 長期目標：2045年實現碳中和。
Long-term target: Carbon neutrality in 2045.



2022年1-4月，極氪001交付量10,378輛，佔公司純電動車總銷量的21%。

During Jan - Apr 2022, deliveries of Zeekr 001 reached 10,378 units, contributing to 21% of the company's total BEVs sales.



2022年1-4月，新能源及電氣化汽車銷量達到63,622輛（同比增長322%），佔公司總銷量的16%；純電動車銷量達到50,510輛（同比增長687%），佔公司新能源及電氣化汽車總銷量的79%。

During Jan - Apr 2022, sales volume of NEEVs reached 63,622 units (+322% YoY), accounting for 16% of the company's total sales; sales volume of BEVs reached 50,510 units (+687% YoY), accounting for 79% of the company's total NEEVs sales.



公開披露「商業行為準則」、「吉利供應商行為準則」、「反腐敗制度」，更清晰透明傳遞企業文化、價值及合規與商業道德要求。

Publicly disclosed the “Code of Business Conduct”, the “Geely Supplier Code of Conduct” and the “Anti-corruption Policy” to transparently convey corporate culture, values, and requirements for compliance and business ethic.



成為首家中國乘用車企業承諾符合科學碳目標倡議（SBTi），並參與SBTi發起「1.5度企業目標」及聯合國發起「奔向零碳」運動。

Became the first Chinese passenger car company to commit to aligning with the Science Based Target (SBTi), and participated in the “Business Ambition for 1.5° C” initiated by SBTi and “Race to Zero” campaign initiated by the United Nations.



發佈《可持續金融框架》並取得Sustainalytics第二方意見，未來將以更低的融資成本發行綠色、可持續發展債券及貸款等。

Published the Sustainable Finance Framework and obtained a second party opinion from Sustainalytics, and will issue green and sustainability bonds and loans with lower financing costs in the future.



獲選為「恆生 ESG 50 指數」及「恆生可持續發展企業基準指數」成份股

Selected as constituent of the “Hang Seng ESG 50 Index” and “Hang Seng Corporate Sustainability Benchmark Index”

獲選為「富時社會責任指數系列」成份股

Selected as constituent of the “FTSE4Good Index Series”

在「香港企業可持續發展指數」中位列恆指成份股前 20 位，并由「表現者」提升至「成功者」。

Ranked top 20 among HSI constituents in the “Hong Kong Business Sustainability Index”, and upgraded from “Performer” to “Achiever”.



Hang Seng Corporate Sustainability Index Series Member 2021-2022



FTSE4Good



Hong Kong Business Sustainability Index 2020
香港企業可持續發展指數 2020



Achiever

淨利(人民幣百萬元) Net Profit (RMB Mn)

→10Yrs CAGR 12%

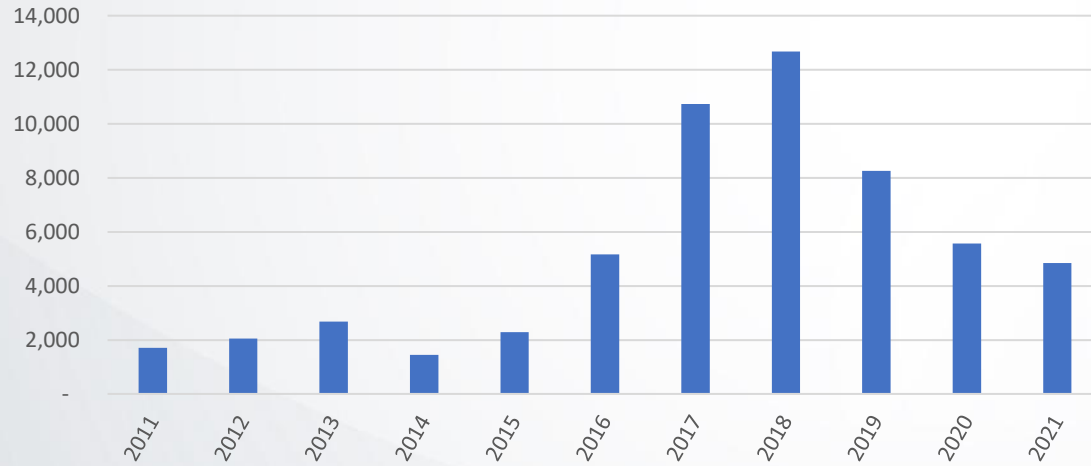

平均出廠價格 (人民幣) Average Ex-factory Prices (RMB)

→10Yrs CAGR 7%



股本回報率(%) Return of Equity (%)

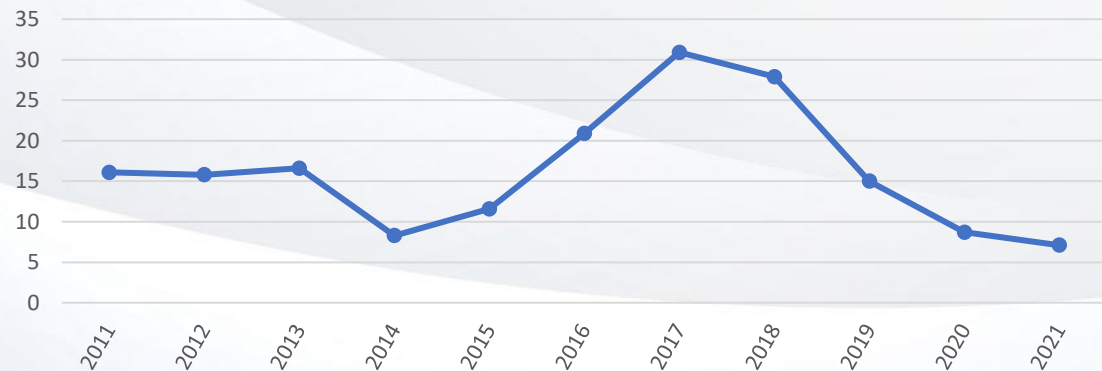

每股股息 (港仙) Cash Dividend Per Share (HK cents)

→10Yrs CAGR 25%

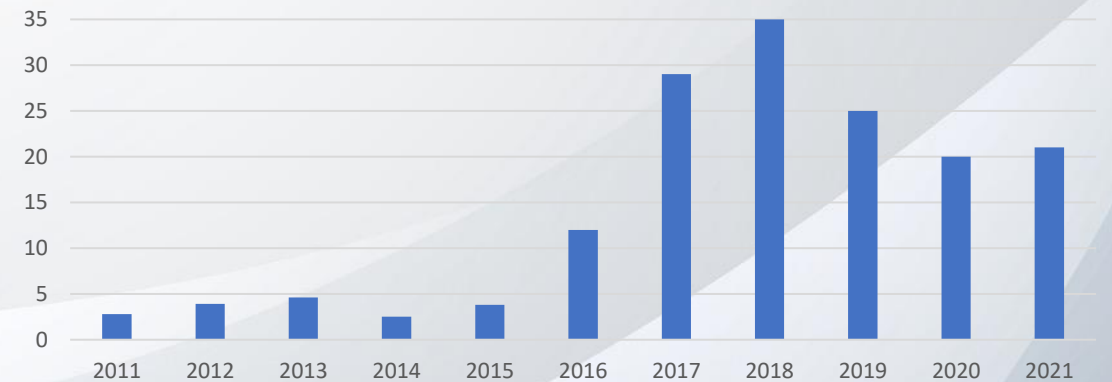

起始年份 Year started	1998
總員工人數 Total workforce	44,000 (於2021年12月31日) 44,000 (on 31 st Dec 2021)
工廠設置 Manufacturing facilities	14家全資中國工廠 14 fully owned plants in China
產品 Products	4個模塊化架構(CMA, BMA, SPA & SEA)為主, 共推出19個主力車型。 19 major models are launched under 4 main modular architectures (CMA, BMA, SPA & SEA)
服務 Services	超過996家吉利經銷商、237家幾何經銷商、619家領克在中國的經銷商和67家極氪直營店。 29個銷售代理, 237個銷售服務網點遍布海外29個國家 (於2021年12月31日) More than 996 Geely dealers, 237 Geometry dealers, 619 LYNK & CO dealers in China and 67 Zeekr direct sales stores. 29 sales agents, 237 sales and service outlets in 29 overseas countries (on 31 st Dec 2021)
2021年銷量 2021 Sales Volume	1,328,029 部 1,328,029 units
2021年收益 2020 Revenue	130億美元 US\$13.05 billion
信貸評級 Credit Rating	標普: BBB-/穩定; 穆迪: Baa3/穩定 S&P:BBB-/Stable; Moody's: Baa3/Stable
市值 Market Capitalization	143億美元(於2022年5月10日) US\$15.4 billion (on 8 th April 2022)

因快乐而伟大



重要告示

本檔之內容僅作演示用途，而任何其他人士不應利用或依賴相關資訊。本檔亦不應被視為替代閣下作出判斷。閣下應單獨負責對本演示材料之討論要點作獨立調查及評估。吉利汽車控股有限公司對本演示材料之內容的準確性、完整性、可靠性概不作任何表示或保證。未經我方事先同意，不得複製及/或分發本演示材料之內容。吉利汽車控股有限公司及其主管人員、董事及雇員對任何人士因依賴本演示材料或其內容而蒙受任何損失或損害，彼等概不負責或承擔法律責任。

注:除另有說明外，本演示材料之所有資料來自吉利汽車控股有限公司。

Important notice

The information contained herein is meant for presentation purposes only and may not be used and relied upon by any other party. It is not to be taken in substitution for the exercise of judgement. You shall be solely responsible for making your own independent investigation of the merits of the discussions mentioned in this presentation. Geely Automobile Holdings Limited does not make any representations, warranties or guarantees as to the accuracy, completeness or correctness of the contents contained herein. The reproduction and/or dissemination of the contents herein is prohibited without our prior approval. Geely Automobile Holdings Limited and its officers, directors and employees accept no liability whatsoever for any direct or consequential loss howsoever arising from any use of this presentation or further communication given in relation to this presentation or its contents or otherwise arising in connection therewith.

Note: Sources of all data contained in this presentation are from Geely Automobile Holdings Limited except specified otherwise.